

WARRANTY

This Tent is covered by a 12 month warranty. The Company undertakes to replace or repair, free of charge, any defect which the Company considers to be due to faulty workmanship or material within 12 months of the purchase date, except for:

- Defects arising from neglect, misuse or unauthorised modifications.
- Damage caused by storm, abuse, misuse, dropping or other similar damage caused by or as a result of failure to follow storage or erection instructions.
- Unauthorised alterations, additions or repairs.
- Transportation or shipment costs to and from the Manufacturer or their recognised agents, for repair or assessment against a warranty claim.
- Damage caused due to UV degradation.
- Materials and/or labour costs to renew, repair or replace components due to fair wear and tear or condensation.
- Tents used on permanent sites or displays.

THIS DOES NOT AFFECT YOUR STATUTORY RIGHTS.

The Manufacturer and/or their recognised agents, directors, employees or insurers will not be held liable for consequential or other damages, losses or expenses in connection with or by reason of or the inability to use the tent for any purpose.

NOTE; Any claim(s) arising due to missing parts or faulty goods MUST be made before use. The manufacturer will not be responsible for any claims regarding missing parts or faulty items where the product has not been checked by the user prior to use.



*Thank you for purchasing the Triumph 800 Tent from SunnCamp.
Before erecting this tent, carefully read and understand these instructions. If there is anything you do not understand, contact your retailer for advice.
By following the instructions on erecting, dismantling, packing and storing the tent you will enjoy many years of trouble free camping.*

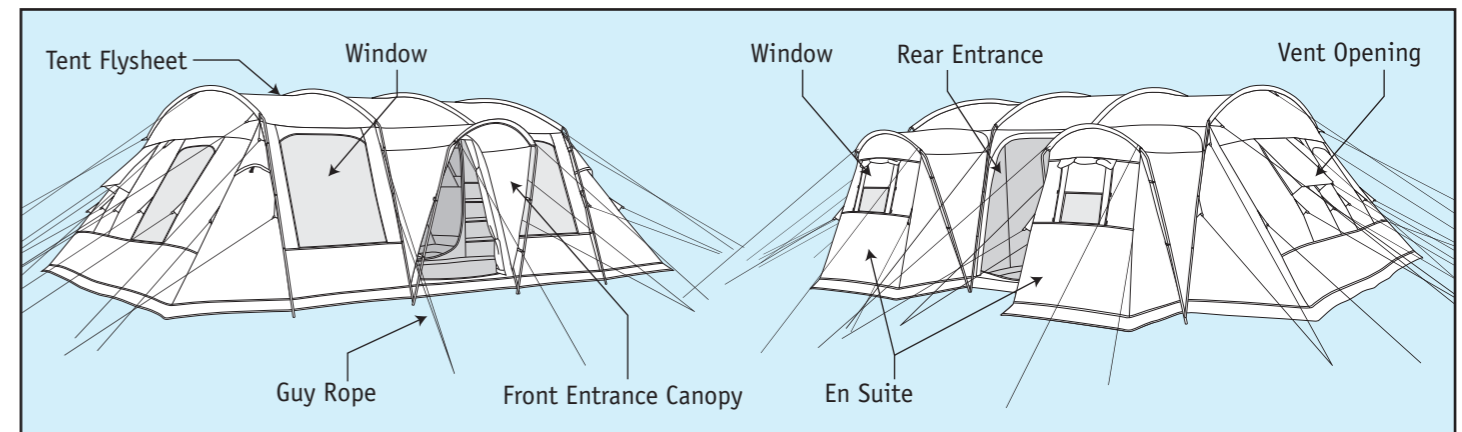

PARTS LISTING

Your Triumph 800 tent consists of the following items and you should check everything is present before setting off.

Tent Flysheet	1
Four Berth Inner Tent	2
Curved Steel Roof Poles	4
Main Steel Legs	8
Fibreglass En Suite / Canopy Roof Poles	3
En Suite / Canopy Legs	6
Tent Peg Bag	1
Tent Carry-Bag	1
Repair Kit	1
OPTIONAL EXTRA	
2 Berth Inner Tent	1

It is a requirement of the warranty that you unpack and erect this tent at home prior to proper use. This will enable you to familiarise yourself with the tent and check all parts are present and in good condition.

If you find any part missing or a fault with your tent, contact the retailer before returning or using it.

SITE SELECTION

Choose a location where the ground is flat, smooth and dry. Position the tent entrance away from the direction of the wind. Do not position on sharp, rocky or rough ground.

GETTING STARTED

Unpack the tent and place the carry-bag somewhere safe. Separate all components and check that everything is present.

POLES

Take each steel pole and slot together.

The Poles are folded down to aid storage. When fitting the pole sections together, make sure that the pole tubes are firmly slotted together.

En suite / Canopy Frame Poles...

Take the en suite and canopy frame poles and slot them together.

TENT

Lay the tent out on the selected ground area with the entrance correctly positioned.

Insert a curved steel pole into each of the four sleeves and connect a leg to either end.

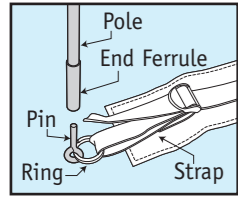

Each leg end is held captive by a pin on a ring fitted to the end of an adjustable webbing strap.

The ring is also used as the securing point for the tent peg.

Starting with a pole at one end of the tent, insert the ring pin into the end of the pole. Next, go to the other end of the pole and insert the ring pin to bring the pole under tension. Repeat this with the remaining poles.

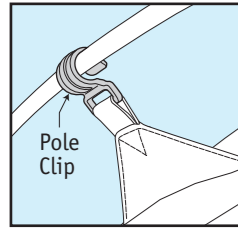

You can now attach the pole clips onto each pole to bring the tent flysheet into the correct shape.

Bring the tent to an upright position by pegging out the front and rear guy ropes. (These may need to be re-pegged at a later stage.)

Entrances...

You should now ensure that all entrances to the tent are closed with all zips fully secured. If this is not done now, the tent will be out of alignment when fitting the tent pegs.

TENT PEGS

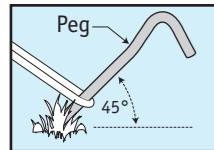

Starting with the four corners, secure the base to the ground using the tent pegs.

Secure the flysheet to the ground by inserting tent pegs through the

pegging points.

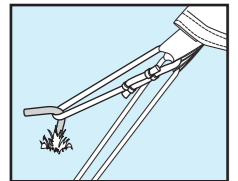

When inserting into the ground, the peg should be set at a 45 degree angle away from the tent. Pegs should be hammered into the ground using a suitable mallet and NOT pressed in with the foot. Most bent

pegs are caused by using your foot rather than a mallet.

Peg removal can be made easier if you use a suitable extractor.

EN SUITE AND CANOPY FRAME POLES

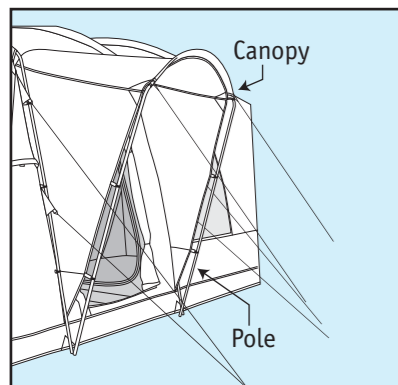

Insert the fibreglass en suite / canopy roof poles into the sleeve which runs across the top of the en suite / canopy fabric.

Next, attach a pair of en suite / canopy legs to each end of the curved roof pole. Finally, insert the ring pin into the end of the

pole at each end, then peg out the two top guy ropes to bring the en suite/porch into shape.

GUY ROPES

Secure each guy rope, positioning its tent peg at a suitable distance from the tent.

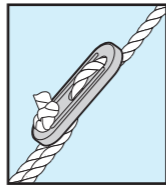

Once in position, tighten the ropes equally to bring the tent into its natural shape. DO NOT over tighten. To tighten, Hold the rope above the slider and pull the slider up. To release, again hold the rope above the slider and pull the slider down.

Remember that all guy ropes are a trip hazard especially in the dark.

INNER TENTS

Fit the lefthand four berth inner tent starting at the back, attaching each ring to its respective toggle. The front outer corner connectors are fitted with a simple clip system. Note that some may be colour coded and you should use this system as a guide for correct location.

Note that both four berth inner tents are fitted with an additional rear opening which allows access to one of the en suites.

The en suite is fitted with its own doorway and a window. This allows light and air to enter the en suite and sleeping area if required.

OPTIONAL TWO BERTH INNER TENT

There is an option to purchase a two berth inner tent, which increases the tents' capacity to 10.

The inner tent should be positioned between the two, four berth inner tents, in front of the rear entrance.

The front outer corner connectors are fitted with a simple clip system. Note that they are colour coded and you should use this system as a guide for correct location.

Note that the two berth inner tent is fitted with an additional rear opening which allows access to the rear entrance.

ENTRANCES

The front entrance is single skinned and the rear entrance dual skinned. Dual skin entrances allow the main cover to be rolled out of the way yet allows ventilation through the meshed secondary cover.

When closed, the zip cover/baffle must be carefully secured into place, ensuring the Velcro tabs are aligned and the skirt correctly positioned, secured by tent pegs, to avoid water ingress should it rain.

VENT OPENING

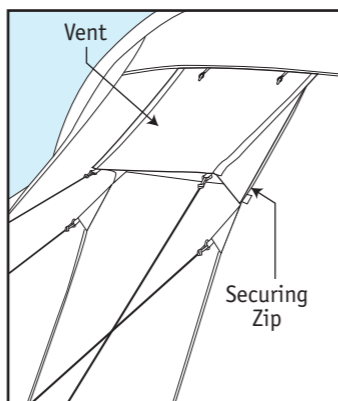

The vent opening offers three options.

Fully closed, it is fastened down by the two securing zips. Note that the zip cover/baffle must be carefully pressed into place to avoid water ingress should it rain.

On vent with the securing zips opened and the cover held open using guy ropes.

Fully open, move the vent zip fully up to separate the sides from the main tent, than roll and secure with toggle and loop.

WINDOWS

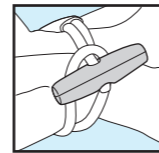

The windows have curtains which can be closed and are secured in place either with hook and loop tape or full length zips. When open, carefully roll the curtain down and secure with toggle and loop.

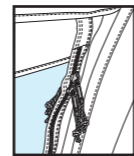

Note that the lefthand inner tent is fitted with a window which in turn is in line with the window fitted to the flysheet. This allows light and air to enter the sleeping areas if required.

SAFETY

It is advisable to have a 'Fire' bucket filled with water, placed outside the tent. Hopefully it will never be needed, but if it is, you will be glad you made the effort.

The tent's fabric is fire retardant, NOT fire proof and therefore you must not smoke or use a naked flame in or near the tent. This includes the traditional 'camp fire'.

Guy ropes can cause a trip hazard and should be marked so that passers by can see them.

Tent pegs are also a trip hazard and should not be left 'half in'.

CLEANING, STORING AND REPAIRS

Cleaning...

Both inside and outside of the tent should only be cleaned using fresh clean water and a damp cloth. Do not use detergents or chemical cleaners.

The inner ground sheet can be washed with a mild detergent.

Storing...

The tent is best stored in its original carry-bag, however, if the tent is dismantled when wet, you MUST not leave it stored until it has been thoroughly dried. After a wet pack-up, erect the tent as soon as possible and allow to fully dry naturally before repacking in the carry-bag.

If stored when wet, the tent will suffer from mildew and will become unusable.

Repairs...

Repairs to the tent should only be made by the manufacturer's recommended agents. Repairs made by an unauthorised party will make the manufacturer's warranty void.

STORM AND WEATHER SUITABILITY

This tent is designed for light use in normal weather conditions. It is not suitable for storms, gales, sub zero or tropical conditions.

UV DETERIORATION

Prolonged exposure to direct sunlight can weaken the fabric of the tent. To avoid the risk of UV Deterioration, site the tent in a shaded area, where it will be protected from exposure to strong sunlight.

MOISTURE

Moisture collecting on the inside of the tent fabric is condensation caused by the occupier. It is NOT a sign of leakage.

Note that condensation or damage caused by it, is NOT covered by the manufacturer's warranty.

SEAMS

This tent has all its main seams hot air taped to help prevent leakage. The remaining seams should be treated with a seam sealant to maximize the tents weatherproofing.

Seam sealant should also be applied to main seams where the tape has lost adhesion or has been damaged (tie points or suspension points for example).

Seam sealant is available from your SunnCamp stockist.

DISMANTLING

To dismantle the tent, simply reverse the erection procedure. Do make sure that the entrance is left open to allow air to escape when rolling the fly sheet up.

All poles must be dismantled and the tent should be carefully rolled prior to placing back in the carry-bag.